

SC 4 EasyFix



Deutsch	5
English	10
Français	16
Italiano	22
Español	27
Português	33
Nederlands	39
Türkçe	45
Svenska	50
Suomi	55
Norsk	60
Dansk	65
Eesti	71
Latviešu	76
Lietuviškai	81
Polski	87
Magyar	92
Čeština	98
Slovenčina	103
Slovenščina	109
Românește	114
Hrvatski	120
Srpski	125
Ελληνικά	130
Русский	136
Українська	143
Қазақша	149
Български	155
العربية	166



Register
your product

www.kaercher.com/welcome



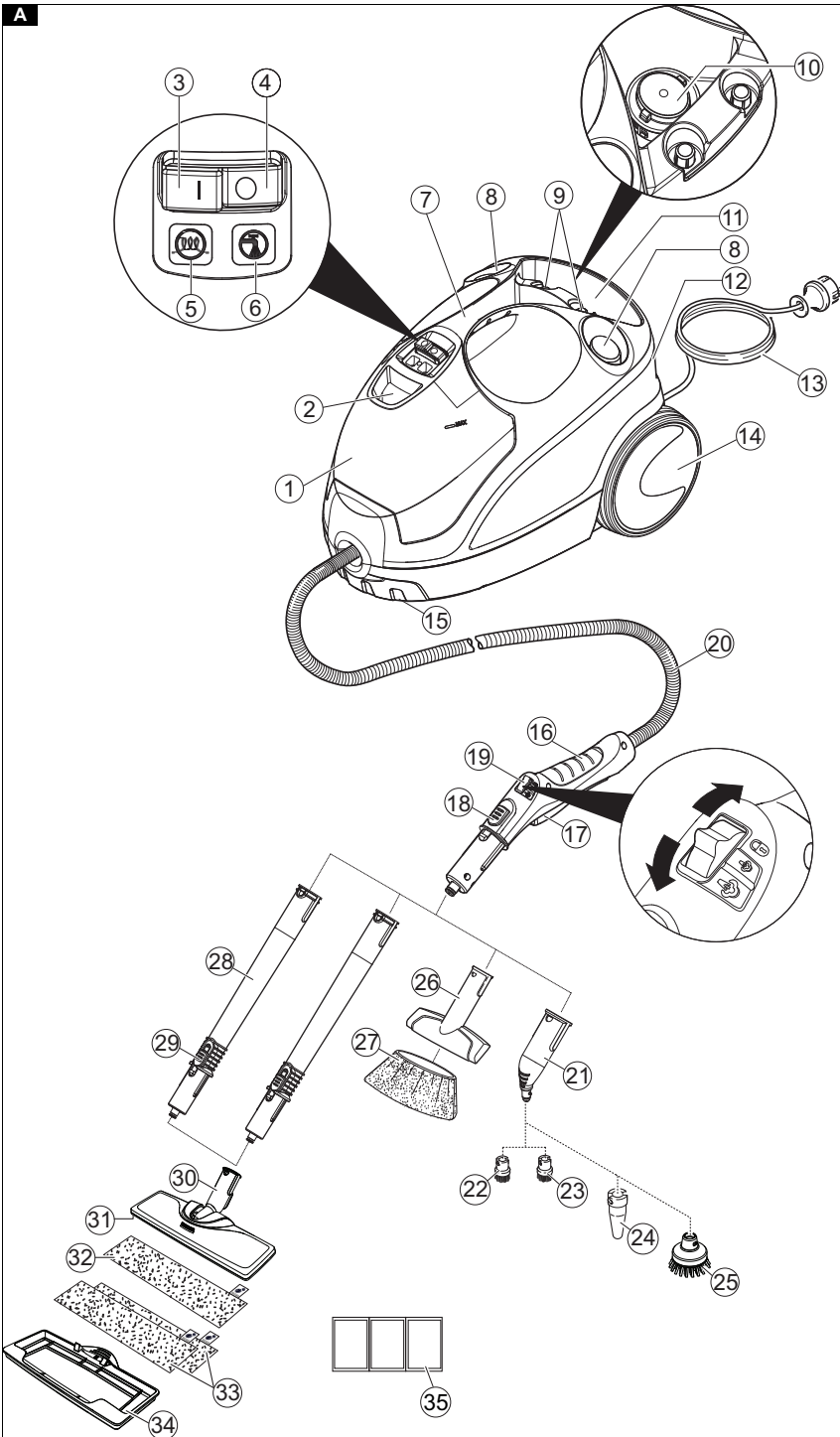

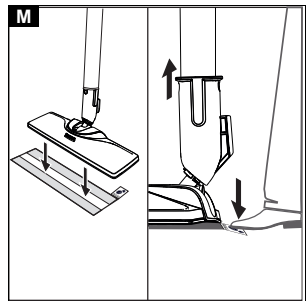
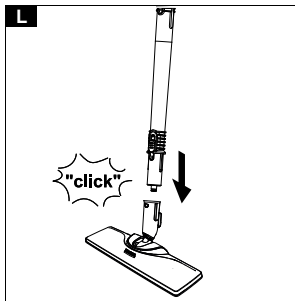
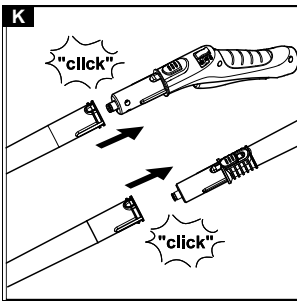
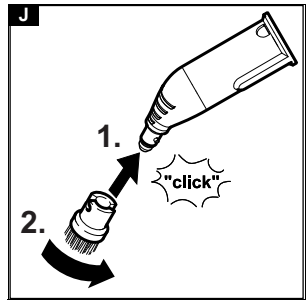
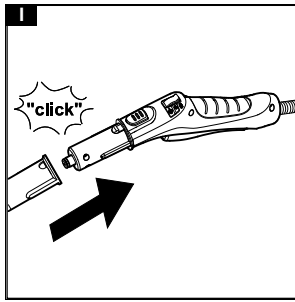
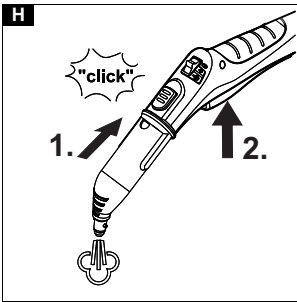
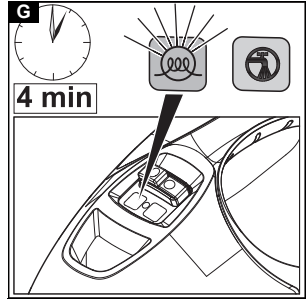
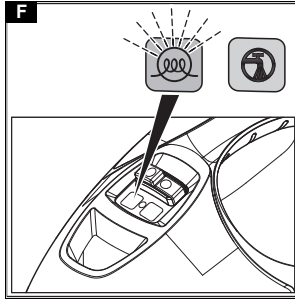
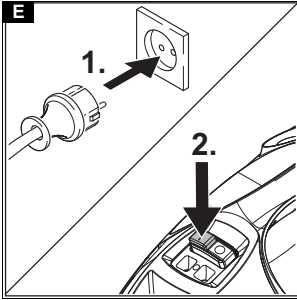
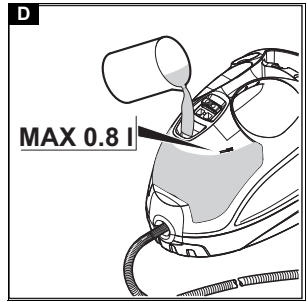
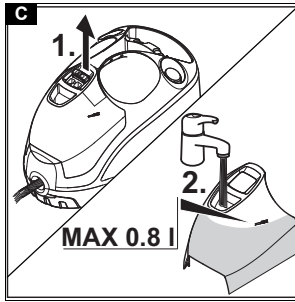
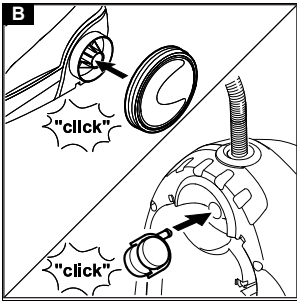

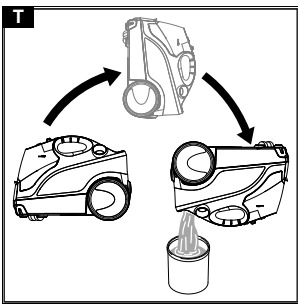
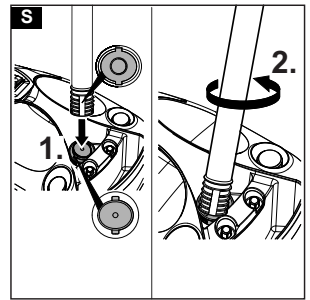
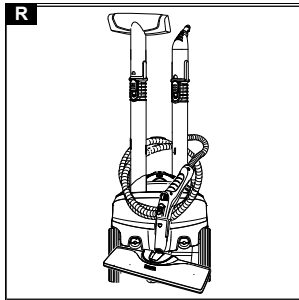
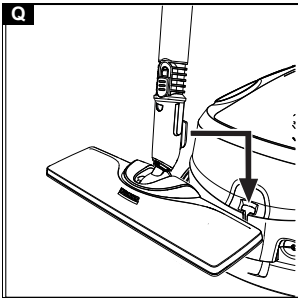
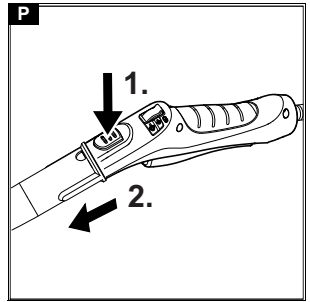
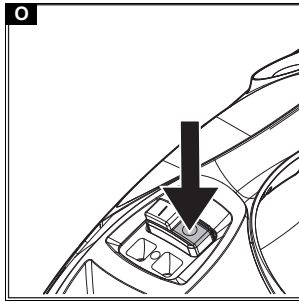
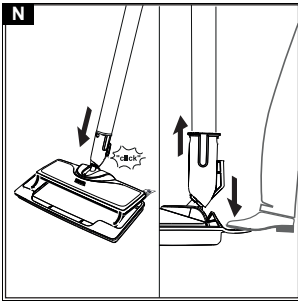

Contents

General notes.....	10
Intended use	10
Environmental protection	11
Accessories and spare parts.....	11
Scope of delivery.....	11
Warranty.....	11
Safety devices.....	11
Description of the device.....	11
Installation	12
Operation	12
Important application instructions.....	13
How to use the Accessories	13
Care and service.....	15
Troubleshooting guide.....	15
Technical data	16

General notes



Read these original operating instructions and the enclosed safety instructions before using the device for the first time. Proceed accordingly.

Keep both books for future reference or for future owners.

Intended use

Only use the appliance in private households. The appliance is intended for cleaning with steam and can be used with appropriate accessories as described in these operating instructions. Detergents are not required. Observe the safety instructions.

Environmental protection



The packing materials can be recycled. Please dispose of packaging in accordance with the environmental regulations.



Electrical and electronic devices contain valuable, recyclable materials and often components such as batteries, rechargeable batteries or oil, which - if handled or disposed of incorrectly - can

pose a potential danger to human health and the environment. However, these components are required for the correct operation of the device. Devices marked by this symbol are not allowed to be disposed of together with the household rubbish.

Notes on the content materials (REACH)

Current information on content materials can be found at: www.kaercher.de/REACH

Accessories and spare parts

Only use original accessories and original spare parts. They ensure that the appliance will run fault-free and safely.

Information on accessories and spare parts can be found at www.kaercher.com.

Scope of delivery

The scope of delivery for the appliance is shown on the packaging. Check the contents for completeness when unpacking. If any accessories are missing or in the event of any shipping damage, please notify your dealer.

Warranty

The warranty conditions issued by our sales company responsible apply in all countries. We shall remedy possible malfunctions on your device within the warranty period free of cost, provided that a material or manufacturing defect is the cause. In a warranty case, please contact your dealer (with the purchase receipt) or the next authorised customer service site. (See overleaf for the address)

Safety devices

⚠ CAUTION

Missing or modified safety devices

Safety devices are provided for your own protection. Never modify or bypass safety devices.

Symbols on the device

(according to type of appliance)

	Risk of burns, surface of appliance becomes hot during operation
	Risk of scalding from steam
	Read operating instructions

Pressure controller

The pressure controller keeps the pressure in the steam boiler as constant as possible during operation. The heating is switched off when the maximum operating pressure is reached in the steam boiler and is activated if there is a pressure drop in the steam boiler as a result of a steam removal.

Safety thermostat

The safety thermostat prevents the device from overheating. If the pressure regulator and the boiler thermostat fail and the unit overheats, the safety thermostat switches the unit off. Before resetting of the safety thermostat, contact the responsible KÄRCHER Customer Service.

Boiler thermostat

The boiler thermostat switches off the heating in the event of a fault; for example, if there is no water in the steam boiler and the temperature in the steam boiler rises.

As soon as you refill the water, the device is ready for use again.

Maintenance lock

The maintenance lock seals the steam boiler from the steam pressure present. The maintenance cap is also a pressure relief valve. If the pressure regulator is defective and the steam pressure in the steam boiler rises, the pressure relief valve opens and steam is escapes through the lock.

Prior to restarting the device, contact the responsible KÄRCHER Customer Service.

Description of the device

The maximum amount of equipment is described in these operating instructions. Depending on the model used, there are differences in the scope of delivery (see packaging).

For the illustrations, refer to the graphics page **Illustration A**

- ① Water reservoir
- ② Filling hole, water reservoir
- ③ Switch - On
- ④ Switch - Off
- ⑤ Indicator light (green) - heating
- ⑥ Indicator light (red) - water shortage
- ⑦ Carrying handle
- ⑧ Holder for accessories
- ⑨ Holder for accessories
- ⑩ Maintenance lock
- ⑪ Mains connection cable storage compartment
- ⑫ Park bracket for floor nozzle
- ⑬ Mains connection with mains plug
- ⑭ Non-driven wheels (2 x)
- ⑮ Steering roller
- ⑯ Steam gun
- ⑰ Steam lever
- ⑱ Unlocking button
- ⑲ Selector switch for steam volume (with child lock)
- ⑳ Steam hose
- ㉑ Spotlight nozzle
- ㉒ Round brush (small, black)

- ②③ ** Round brush (small, yellow)
- ②④ ** Power nozzle
- ②⑤ ** Round brush (large)
- ②⑥ Manual nozzle
- ②⑦ Microfibre cover for manual nozzle
- ②⑧ Extension tubes (2 x)
- ②⑨ Unlocking button
- ③⑩ Floor nozzle
- ③⑪ Hook and loop fastener
- ③⑫ Microfibre floor cloth (1 x)
- ③⑬ ** Microfibre floor cloth (2 x)
- ③⑭ ** Carpet glider
- ③⑮ Descaler

** optional

Installation

Installing accessories

1. Insert and engage the steering roller and non-driven wheels.
Illustration B
2. Push the open end of the accessory onto the steam gun so that the unlocking button on the steam gun engages.
Illustration I
3. Push the open end of the accessory onto the spot-light nozzle.
Illustration J
4. Connect the extension tubes with the steam gun.
 - a Push the 1st extension tube onto the steam gun so that the unlocking button on the steam gun engages.
The connection pipe is connected.
 - b Push the 2nd extension tube onto the 1st extension tube.
The connection pipes are connected.
5. Push the accessory and / or the floor nozzle onto the free end of the extension tube.
Illustration L
The accessory is connected.

Disconnecting accessories

1. Set the selector switch for the steam volume to the rear.
The steam lever is locked.
2. Push the unlocking button and pull the parts apart.
Illustration P

Operation

Filling water

The water reservoir can be removed at any time for filling or be filled directly at the device.

ATTENTION

Damage to the device

Unsuitable water can block the nozzles or damage the water level indicator.

Do not fill in pure distilled water. Use a maximum of 50% distilled water mixed with tap water.

Do not use condensation from the clothes dryer for filling.

Do not use collected rain water for filling.

Do not use cleaning agents or other additives (e.g. scents) for filling.

Remove the water reservoir for filling

1. Pull the water reservoir vertically upwards.
Illustration C
2. Fill the water tank vertically with tap water or a mixture of tap water and no more than 50% distilled water up to the "MAX" mark.
3. Insert the water reservoir and press downwards until it locks into place.

Filling the water reservoir directly on the device

1. Fill tap water or a mixture of tap water and no more than 50% distilled water from a vessel into the filling hole of the water reservoir up to the "MAX" mark.
Illustration D

Switching on the device

Note

If there is no or too little water in the steam boiler, the water pump starts to run and pumps water from the water reservoir into the steam boiler. The filling process can take several minutes.

Note

The device briefly closes the valve every 60 seconds causing an audible soft click. Closing prevents the valve from clogging. This does not affect the steam output.

1. Place the device on a firm surface.
2. Insert the mains plug into a socket.

Illustration E

3. Press the ON switch.
The green heating indicator light flashes.

Illustration F

4. Wait until the green heating indicator stays on.

Illustration G



5. Press the steam lever.

Illustration H

Steam leaks out.

Regulating the steam volume

The expelled steam volume is regulated using the selector switch for steam volume. The selector switch has 3 positions:

	Maximum steam volume
	Reduced steam volume
	No steam - child lock Note <i>In this position, the steam lever cannot be operated.</i>

1. Set the selector switch for the steam volume to required steam volume.
2. Press the steam lever.
3. Before starting cleaning, point the steam gun at a cloth until steam is expelled evenly.

Refilling water

If there is not enough water, the water shortage indicator lamp flashes red and a signal tone sounds.

Note

The water pump fills the steam boiler at intervals. If the filling is successful, the red water shortage indicator lamp goes out.

Note

If there is no or too little water in the steam boiler, the water pump starts to run and pumps water from the water reservoir into the steam boiler. The filling process can take several minutes.

ATTENTION

Damage to the device

Unsuitable water can block the nozzles or damage the water level indicator.

Do not fill in pure distilled water. Use a maximum of 50% distilled water mixed with tap water.

Do not use condensation from the clothes dryer for filling.

Do not use collected rain water for filling.

Do not use cleaning agents or other additives (e.g. scents) for filling.

1. Fill the water tank with tap water or a mixture of tap water and no more than 50% distilled water up to the "MAX" mark.

The device is ready for use.

Switching off the device

1. Press the OFF switch.

Illustration O

The device is switched off.

2. Set the child lock (selector switch for steam volume) to the rear.
The steam lever is locked.
3. Pull the mains plug out of the socket.
4. Drain the water reservoir.

Rinsing out the steam boiler

Rinse the device's steam boiler out after every tenth filling of the tank.

1. Switch the device off; see Chapter *Switching off the device*.
2. Allow the device to cool down.
3. Drain the water reservoir.
4. Remove the accessory/accessories from the accessory holders.
5. Open the maintenance lock. To do this place the open end of an extension tube on the maintenance lock, insert this into the guide so it engages and open it.

Illustration S

6. Fill the steam boiler with water and swing it around vigorously. Lime residue which has been deposited on the bottom of the steam boiler will be released as a result.
7. Drain the water completely out of the steam boiler.

Illustration T

Storing the device

1. Connect the extension tubes to the large mounts for accessories.
2. Connect a manual nozzle and spotlight nozzle to each extension tube.
3. Fasten the large round brush to the spotlight nozzle.
4. Connect the small round brush and nozzles to the medium-sized mount for accessories.

5. Hang the floor nozzle in the park bracket.

Illustration Q

6. Wind the steam hose around the extension tube and connect the steam gun to the floor nozzle.

Illustration R

7. Wind the mains cable around the extension tube.
8. Stow the mains cable in the accessory compartment.
9. Store the device in a dry location that is protected from frost.

Important application instructions

Cleaning the floor areas

We recommend sweeping the floor or vacuum cleaning it before using the appliance. In this way the floor will be cleared of dirt and loose particles before the wet cleaning.

Freshening up textiles

Prior to using the appliance, always check the compatibility of the textiles at a concealed point: Steam down the textile, allow it to dry and then check it for any change in colour or shape.

Cleaning coated or painted surfaces

ATTENTION

Damaged surfaces

Steam can loosen wax, furniture polish, plastic coatings or paint and edge band from edges.

Do not direct the steam at glued laminated edges as the edge band may loosen.

Do not use the appliance for cleaning unsealed wood or parquet floors.

Do not use the appliance for cleaning painted or plastic coated surfaces such as kitchen or living room furniture, doors or parquet.

1. To clean these surfaces, steam a cloth briefly and use it to wipe over the surfaces.

Glass cleaner

ATTENTION

Glass breakages and damaged surfaces

Steam can damage sealed points of the window frame and, at low outside temperatures, lead to tension on the surface of window panes and hence to glass breakages. Do not direct the steam at sealed points on the window frame.

At low outside temperatures, heat up the window panes by gently steaming the full surface of the glass.

- Clean the window area with a manual nozzle and cover. To remove the water, use a squeegee or wipe the surfaces dry.

How to use the Accessories

Steam gun

The steam gun can be used for the following applications without accessories:

- For removing slight creases from the hanging clothing items: Steam the clothing item from a distance of 10-20 cm.
- For wiping damp dust: Steam a cloth briefly and use it to wipe over the furniture.

Spotlight nozzle

The spotlight nozzle is suitable for cleaning areas, joins, fittings, drains, sinks, WCs, blinds or radiators that are difficult to access. The closer the spotlight nozzle is to

the soiled area, the greater the cleaning efficiency will be as the temperature and steam volume are at their highest at the nozzle opening. Larger lime deposits can be treated before steam cleaning with a suitable detergent. Allow the detergent to soak in for approx. 5 minutes and then steam it off.

1. Slide the spotlight nozzle onto the steam gun.

Illustration I

Round brush (small)

The small round brush is used for cleaning stubborn dirt. Stubborn dirt can be removed more easily by brushing.

ATTENTION

Damaged surfaces

The brush may scratch sensitive surfaces. It is not suitable for cleaning sensitive surfaces.

1. Fit the round brush to the spotlight nozzle.

Illustration J

Round brush (large)

The large round brush is suitable for cleaning large rounded surfaces, e.g. wash basin, shower tray, bath tub, kitchen sink.

ATTENTION

Damaged surfaces

The brush may scratch sensitive surfaces. It is not suitable for cleaning sensitive surfaces.

1. Fit the large round brush to the spotlight nozzle.

Illustration J

Power nozzle

The power nozzle is used for cleaning stubborn dirt, blowing down corners, joints etc.

1. Install the power nozzle onto the spotlight nozzle according to the round brush.

Illustration J

Manual nozzle

The manual nozzle is used for cleaning small areas that can be washed down, shower cubicles and mirrors.

1. Push the manual nozzle onto the steam gun according to the spotlight nozzle.

Illustration I

2. Pull the cover over the manual nozzle.

Floor nozzle

The floor nozzle is used for cleaning washable wall and floor coverings e.g. stone floors, tiles and PVC floors.

ATTENTION

Damage due to build-up of steam

Heat and moisture can lead to damage.

Check the heat resistance and steam effect on an inconspicuous area using a minimal volume of steam prior to use.

Note

Detergent residue or care emulsions on the surface to be cleaned can lead to streaks during steam cleaning, which will disappear however once these have been used several times.

We recommend sweeping the floor or vacuum cleaning it before using the device. In this way the floor will be cleared of dirt and loose particles before the wet cleaning commences. Work slowly on surfaces that are heavily soiled so that the steam has longer to take effect.

1. Connect the extension tubes with the steam gun.

Illustration K

2. Push the floor nozzle onto the extension tube.

Illustration L

3. Fasten the floor cleaning cloth to the floor nozzle.

- a Place the floor cleaning cloth with the hook and loop fastener strips pointing upwards on the floor.
- b Place the floor nozzle onto the floor cleaning cloth, applying slight pressure.

Illustration M

The floor cleaning cloth will stick to the floor nozzle of its own accord due to the hook and loop fastener.

Removing the floor cleaning cloth

1. Place one foot on the bottom corner of the floor cleaning cloth and lift the floor nozzle up.

Illustration M

Note

Initially, the floor cleaning cloth's hook and loop fastener strip is very strong and cannot be removed from the floor nozzle easily. After the floor cleaning cloth has been used several times and washed, it is easier to remove from the floor nozzle and it has reached the optimum adhesion.

Parking the floor nozzle

1. Hang the floor nozzle in the park bracket during breaks in work.

Illustration Q

Carpet glider

The carpet glider is used for freshening up carpets.

ATTENTION

Beware of damaging the carpet glider and carpet
Contamination on the carpet glider, as well as heat and moisture penetration, can result in the carpet being damaged.

Prior to the application, also check the heat resistance and impact of steam on the carpet at an insignificant spot using as small an amount of steam as possible. Observe the cleaning instructions from the carpet manufacturer.

Prior to using the carpet glider, make sure that the carpet has been vacuumed and that stains have been removed.

Prior to application and following operating pauses, remove any possible water accumulation (condensate) in the appliance by means of evaporating the condensate into a drain (without floor cleaning cloth / with accessories).

Only use the carpet glider with a floor cleaning cloth on the floor nozzle.

Steam clean with a weak steam stage when using the carpet glider.

In order to prevent too much moistening and to avoid the risk of damage due to temperature effects, do not direct the steam continuously onto one spot (maximum 5 seconds).

Do not use the carpet glider on deep-pile carpets.

Fastening the carpet glider to the floor nozzle

1. For fastening the floor cleaning cloth to the floor nozzle, please refer to chapter *Floor nozzle*.

Illustration M

2. Using a little force, allow the floor nozzle to slide into the carpet glider and engage there.

Illustration N

3. Start cleaning the carpet.

Removing the carpet glider from the floor nozzle

⚠ CAUTION

Beware of burns to your feet

The carpet glider can heat up during the steaming process.

Do not operate or remove the carpet glider bare-footed or using open sandals.

Only operate or remove the carpet glider using suitable footwear.

1. Press the strap on the carpet glider downwards using your toecap.
2. Lift the floor nozzle upwards.

Illustration N

Care and service

Descaling the steam boiler

Note

Since the lime clogs the appliance, we recommend descaling the appliance based on the number of times the water reservoir is filled as specified in the table (TF=tank fillings).

Hardness range	°dH	mmol/l	TF	
I	soft	0-7	0-1.3	100
II	Medium	7-14	1.3-2.5	90
III	Hard	14-21	2.5-3.8	75
IV	Very hard	>21	>3.8	50

Note

Your water board or municipal utilities authority can provide information on hardness of tap water.

ATTENTION

Damaged surfaces

The descaler may corrode sensitive surfaces.

Fill and empty the appliance carefully.

1. Switching off the device, see chapter *Switching off the device*.
2. Allow the device to cool down.
3. Drain the water reservoir.
4. Remove the accessory/accessories from the accessory holders.
5. Open the maintenance lock. To do this place the open end of an extension tube on the maintenance lock, insert this into the guide so it engages and open it.

Illustration S

6. Drain the water completely out of the steam boiler.

Illustration T

ATTENTION

Appliance damage due to descaler

An unsuitable descaler or incorrect dosing of the descaler may damage the appliance.

Only use KÄRCHER descaler.

Use 1 dosing unit of the descaler for 0.5 l water.

7. Apply descaler solution to the descaler according to the details.
8. Fill the descaler solution into the steam boiler. Do not seal the steam boiler.
9. Allow the descaler solution to take effect for approx. 8 hours.
10. Drain descaler solution completely out of the steam boiler.
11. Repeat the descaling process if necessary.
12. Rinse the steam boiler 2-3 times with cold water in order to drain all the descaler solution residue.
13. Drain the water completely out of the steam boiler.
14. Dry the mounting for the grid connection cable.
15. Close the maintenance lock with an extension tube.

Care of accessories

(Accessories - depending on scope of delivery)

Note

The micro fibre cloths are not suitable for dryer.

Note

When washing the cloths, observe the instructions on the washing tag. Do not use any liquid softeners as this will affect the ability of the cloths to pick up dirt.

1. Wash the floor cleaning cloths and covers at a max. temperature of 60 °C in the washing machine.

Troubleshooting guide

Malfunctions often have simple causes that you can remedy yourself using the following overview. When in doubt, or in the case of malfunctions not mentioned here, please contact your authorised Customer Service.

⚠ WARNING

Risk of electric shock and burns

Trying to eliminate faults while the appliance is connected to the mains or has not yet cooled down is always dangerous.

Remove the mains plug.

Allow the appliance to cool down.

Reduced steam quantity

The steam boiler is scaled.

- Descalate the steam boiler.

The water shortage indicator light flashes red and a signal tone sounds

No water in the tank.

- Fill the water reservoir up to the "MAX" marking.

The water shortage indicator light is lit in red

No water in the steam boiler. The pump's overheat protection has triggered.

1. Switch the device off; see Chapter *Switching off the device*.
2. Fill the water reservoir.
3. Switch on the device; see Chapter *Switching on the device*.

The water tank is not inserted correctly or is calcified.

1. Remove the water reservoir.
2. Rinse the water reservoir.
3. Insert the water reservoir and press downwards until it locks into place.

The steam lever cannot be pressed

The steam lever is locked with the child lock.

- Set the child lock (selector switch for steam volume) to the front.

The steam lever is released.

Long heating-up time

The steam boiler is scaled.

- Descalate the steam boiler.

High water output

The steam boiler is scaled.

- Descalate the steam boiler.

Technical data

SC 4

Electrical connection

Voltage	V	220-240
Phase	~	1
Frequency	Hz	50-60
Degree of protection		IPX4
Protection class		I

Device performance data

Heating capacity	W	2000
Maximum operating pressure	MPa	0.35
Heating-up time	Minutes	4
Continuous steaming	g/min	50
Maximum steam blast	g/min	110

Filling quantity

Water reservoir	l	0.8
Steam boiler	l	0.5

Dimensions and weights

Weight without accessories	kg	4.1
Length	mm	350
Width	mm	280
Height	mm	270

Subject to technical modifications.



THANK YOU!
MERCI! DANKE! ¡GRACIAS!



Registrieren Sie Ihr Produkt und profitieren Sie von vielen Vorteilen.

Register your product and benefit from many advantages.

Enregistrez votre produit et bénéficiez de nombreux avantages.

Registre su producto y aproveche de muchas ventajas.

www.kaercher.com/welcome



Bewerten Sie Ihr Produkt und sagen Sie uns Ihre Meinung.

Rate your product and tell us your opinion.

Évaluer votre produit et dites-nous votre opinion.

Reseñe su producto y díganos su opinión.



www.kaercher.com/dealersearch

Alfred Kärcher SE & Co. KG
Alfred-Kärcher-Str. 28-40
71364 Winnenden (Germany)

